

ID-Nr. 30616-892
Model SL.060.140.UB.3T



Cabinet for acids and alkalis SL-CLASSIC-UB
Model SL.060.140.UB.3T, light grey

Safe and approved storage of aggressive, non flammable hazardous materials in working areas

Function / construction:

- **Robust construction and longevity:** made out of highly resistant melamin resin special plates
- **User-friendly:** access to all containers, 93° opening of the wing door, interior of the cabinet completely visible
- **No unauthorised use:** doors lockable with cylinder lock and locking state indicator (red/green)
- **Mobile:** castors with plinth (optionally available), easy moving of the cabinet
- **Ventilation:** integrated air ducts ready for connection (DN 50) to a technical exhaust system

Dimensions	
Width (external)	1400.00 mm
Depth (external)	570.00 mm
Height (external)	600.00 mm
Width (internal)	489.00 mm
Depth (internal)	531.00 mm
Height (internal)	562.00 mm

The available internal dimensions can vary depending on the interior equipment package.

Weight / Load	
Weight without interior equipment	66 kg
Distributed load	82.00 kg/m ²
Maximum load	100 kg

Ventilation	
Extraction air	50 DN
Recom. exhaust air quantity 30 times	9 m ³ /h
Differential pressure (30 times air change)	10 Pa
Minimum exhaust air quantity 10 times	3 m ³ /h
Differential pressure (10 times air change)	10 Pa

Colouring / Surface finish	
Body colour	light grey
Body surface finish	micropearl
Door / Drawer colour	light grey
Door / Drawer surface finish	micropearl

General Information	
Number of doors	3
Depth with open doors	1094 mm
Customs tariff number	94032080

Front view

Side view

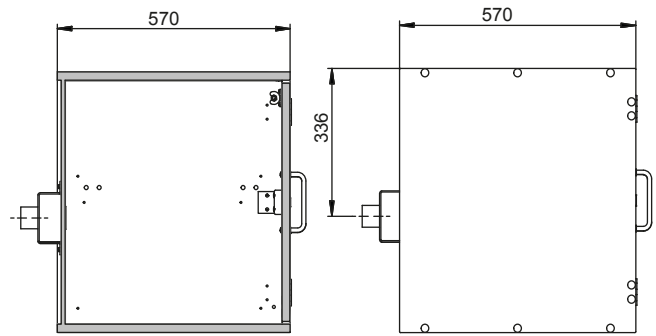
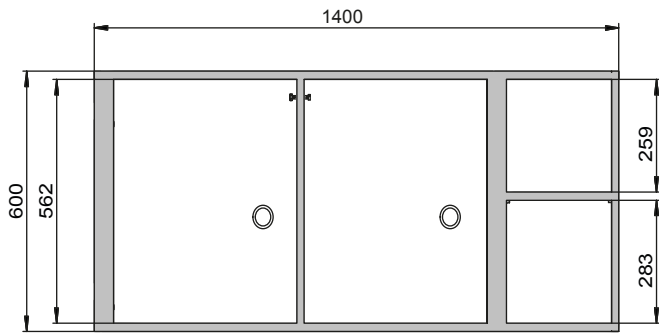

Top view

