

DENIOS.



Technical changes reserved

Operating instructions **SpillGuard®**



Output 2023-09
Original instructions

Copyright

DENIOS SE

Dehmer Straße 54-66

32549 Bad Oeynhausen

Tel. +49 5731 753-0

Fax +49 5731 753-199

Email info@denios.de

These instructions contain texts, images and drawings which need express written authorisation before they can be reproduced, distributed or otherwise shared, in part or in full.

These instructions represent the legal situation in Germany.

IMPORTANT

Read carefully before commissioning

Keep safe for later reference

© Copyright DENIOS SE

Table of contents

1	Notes on the operating instructions	5
1.1	Warnings	5
1.2	Instructions for use	7
1.3	Labelling	7
2	Safety instructions	9
2.1	Intended use	10
2.1.1	Misuse	10
2.2	Operator duties	11
2.2.1	Before commissioning	11
2.2.2	Obligation to inspect spill sumps	11
2.2.3	Spill sump resistance	12
2.2.4	Compliance with the requirements of the safety data sheet	12
2.2.5	Training	12
2.2.6	Use in Ex zones - explosion protection requirements	13
2.3	Personnel requirements	14
3	Transport and storage	15
3.1	Unpacking	15
4	Product description	16
4.1	Overview	16
4.2	Dimensions	18
4.3	Technical data	19
4.3.1	Explanation of the nameplate	20
5	Installation	21
5.1	Requirements for the installation location	21
6	Operation	23
6.1	Commissioning the product	23

6.2 Using the product in a new location.....24

6.3 Carrying out measures if the alarm is triggered24

7 Faults and incorrect operation.....26

7.1 Possible faults.....26

8 Maintenance28

9 Decommissioning.....29

9.1 Switching off.....29

9.2 Cleaning30

10 Disposal.....31

11 EU conformity.....32

1 Notes on the operating instructions

Before you set up and commission your product, ensure you read these operating instructions completely. Always take note of the safety notices and warnings.

These operating instructions are for anyone who comes directly into contact with the product.

These operating instructions form part of the product.

Further applicable documents

Depending on the product, you will receive the following documents separately as part of your delivery:

- Quick Guide
- EU Declaration of Conformity (Download)
- Resistance list (Download)

Differences are possible depending on country.

1.1 Warnings

Warnings are shown at the start of a chapter or section before instructions for use where a hazard may occur. The warnings are structured as follows:



DANGER



The symbol shows the type of hazard.

Symbol and signal word show a hazard which leads to serious injury or death.

- Measure.



WARNING



The symbol shows the type of hazard.

Symbol and signal word show a hazard which can lead to serious injury or death.

- Measure.



CAUTION



The symbol shows the type of hazard.

Symbol and signal word show a hazard which can lead to minor injury.

- Measure.

NOTICE

Signal word shows a hazard which can lead to damage to property.



Symbol shows instructions for use and other useful information.

Pictograms are used to warn of hazards:

Pictogram	Meaning
	General warning

1.2 Instructions for use

These operating instructions contain various instructions for use.

Perform the following action

- ✓ This is a requirement.
- 1. This is an action step.
- ⇒ This is an intermediate result.
- 2. This is another action step.
- This is the final result.

1.3 Labelling

Italic text

Is used to emphasise individual words or phrases

Cross reference [▶ 7]

Indicates that content is explained on another page

NOTICE! Text.

Important information in the text, instructions for use or tables

CAUTION! Text.

WARNING! Text.

DANGER! Text.



Important information for explosion protection



Refers to an audible signal after an action step



Refers to a visual signal after an action step

 www.denios.com/spillguard

Further information available to download

2 Safety instructions

This section gives important notices for safe use of the product. These notices are to protect employees and to ensure safe, fault-free operation. Warnings relating to use can be found in the corresponding instructions for use.

The product is built in accordance with the state of the art and the recognised technical rules.

There may be hazards associated with the product if it is used, maintained or repaired in an incorrect manner, not in accordance with the intended use or by untrained personnel.

Hazards may arise affecting:

- Health and life of personnel
- Product and other assets near the product

Follow all the safety instructions in these operating instructions as well as all safety instructions in the operating instructions of our suppliers which have been provided.

Ensure that the national directives and safety regulations relating to hazardous substances, safety directives, industrial safety and operator duties are observed.

2.1 Intended use

SpillGuard® is a mains-power-independent leak recognition system for detecting leaks of liquids / liquid hazardous substances. SpillGuard® is designed for use in clean, uncontaminated spill sumps, which are set up indoors.

The spill sumps should preferably be in metal or non-metallic (plastic) materials. Outdoor use is not permitted.

SpillGuard® may only be used within the limits for use defined on the nameplate. SpillGuard® is suitable for Ex zone 0, due to gases and vapours.

SpillGuard® may only be used as a precaution with the liquids which have already been positively tested by DENIOS. The list can be found here:

 www.denios.com/spillguard

Suitability must be tested for substances which are not in the list.



The resistance list contains a representative selection of liquid hazardous substances. If required, DENIOS can carry out a function and resistance test for your substance. The test includes checking that the substance is correctly detected and also that the alarm signal is then maintained for 24 h (resistance test).

2.1.1 Misuse

DENIOS takes no responsibility for any damage caused by contravention of the intended use. All warranties and guarantees are excluded in the event of misuse. The party causing the misuse is solely responsible for any consequential damage.

The following are considered as not in accordance with the intended use:

- Using SpillGuard® in spill sumps for storing non-approved media
- Using SpillGuard® in potentially explosive areas outside the nameplate limits
- Using SpillGuard® in potentially explosive areas caused by dust
- Using SpillGuard® again after a leaked substance has been successfully detected
- Using substances which are not suitable for use with SpillGuard® :

 www.denios.com/spillguard

- Disregarding applications which are expressly described as permitted
- Changing the battery

WARNING! If the housing is opened in Ex atmospheres there is a risk of explosion. Opening the housing can lead to severe injuries or death. Opening the housing is prohibited.

2.2 Operator duties

2.2.1 Before commissioning

Check the product for damage.

2.2.2 Obligation to inspect spill sumps

SpillGuard® is an additional safety measure, which indicates a leak using a visible and an audible signal.

Regardless of using SpillGuard® the operator of containment devices is obliged to carry out and document the weekly visual inspections required by the steel spill sump guidelines (Stawa R) and the General Technical Approval.

Use of SpillGuard® does not mean that the operator of the equipment is no longer required to comply with this obligation.

2.2.3 Spill sump resistance



The corrosion resistance of the materials used to make the spill sump and their compatibility with the substances stored must be demonstrated.

For many chemical substances steel spill sumps (1.0038) may be used. Plastic (polyethylene) spill sumps are frequently required if corrosive substances (acids / alkalis) are being stored. Stainless steel offers the best protection, especially against many aggressive liquids. If no information is given in the resistance lists, the material of the spill sump may be the same material as the transport container.

2.2.4 Compliance with the requirements of the safety data sheet

A safety data sheet must be prepared by the distributor for each hazardous substance, in accordance with REACH legislation.

As the operator, you must observe the safety and hazard information in the safety data sheet.

2.2.5 Training

Personnel in question must be sufficiently trained at regular intervals, and especially if changes or adjustments are made. Employees must be trained when the product is used in Ex **zone 0**, especially on the measures for the avoidance of explosion hazards set out in the risk assessment and explosion protection document.

2.2.6 Use in Ex zones - explosion protection requirements



Storage systems for flammable liquids are systems requiring monitoring within the meaning of the Product Safety Act (ProdSG) § 2 Para. 30 with explosion hazard. The requirements to be derived from this are described in the applicable technical rules for the German Industrial safety regulations (BetrSichV) and the Hazardous substance regulations (GefStoffV). According to the German Industrial safety regulations (BetrSichV), the operator of this equipment is obliged to carry out a risk assessment. In addition, the operator is obliged to produce an explosion protection document in which appropriate protective measures are defined in order to avoid explosion hazards.

In addition, Directive 1999/92/EC sets out the minimum regulations for improving work health and safety for employees who may be at risk due to explosive atmospheres. The main contents are:

- Duty of coordination
- Explosion protection document
- Classification of areas where an explosive atmosphere may be present
- Minimum regulations for improving work health and safety for employees who may be at risk due to explosive atmospheres as well as criteria for selecting equipment and protection systems

The explosion protection document produced by the operator specifies the conditions at the location of use. The operator must test in detail whether the product meet the requirements of the explosion protection document.

The product is to be included in the preparation of the explosion protection document

and the measures it contains.

Further additional operator measures also include:

- Include the storage system in the local equipotential bonding measures to avoid electrical compensation currents.
- The same applies for the avoidance of sources of ignition, discharge of static electricity, connection to the equipotential bonding system is required here.
- If the containers are filled with flammable liquids on the system components: consider the additional measures regarding discharge of static electricity in accordance with TRGS 727.
- To comply with the discharge values, keep the bearing surface free of paint residues, hazardous material residues or unwanted insulation.
- Operate the storage system so that process-related electrostatic charges are ruled out (e.g. from cleaning work, see also TRGS 727 Sections 4 and 5).

2.3 Personnel requirements

Risk-free working is only possible, when only specially qualified personnel set up and use the product.

Persons undergoing training may only be permitted to work with the product, if a qualified person is constantly supervising the work.

3 Transport and storage

The product is supplied in a cardboard pack together with a Quick Guide and inlay sheet.

Store the product as follows:

- Dry
- At room temperature
- NOT outdoors
- NOT in direct sunlight

3.1 Unpacking

Perform the following action

- ✓ The pack is not damaged.
1. Open the cardboard pack.
 2. Remove the contents.
 3. Keep the Quick Guide to hand near the product.



4 Product description

4.1 Overview



Fig. 1: Top view

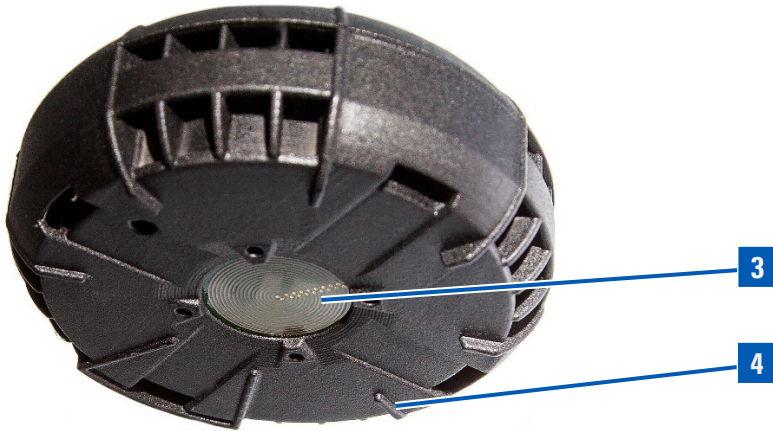



Fig. 2: Bottom view

	Element	Function
1	 "Red" LED	The "red" LED illuminates during commissioning, operation and when an alarm is triggered.
2	 Push button	The push button is used to switch SpillGuard® on and off and also to turn off the signal when an alarm has been triggered.
3	Sensor surface	If the sensor surface becomes wet, it detects a leak and triggers the audible and visible signal.
4	Foot	The different height feet ensure the product is stable. The different height feet ensure that a leaked liquid reaches the sensor surface without any bubbles.

4.2 Dimensions

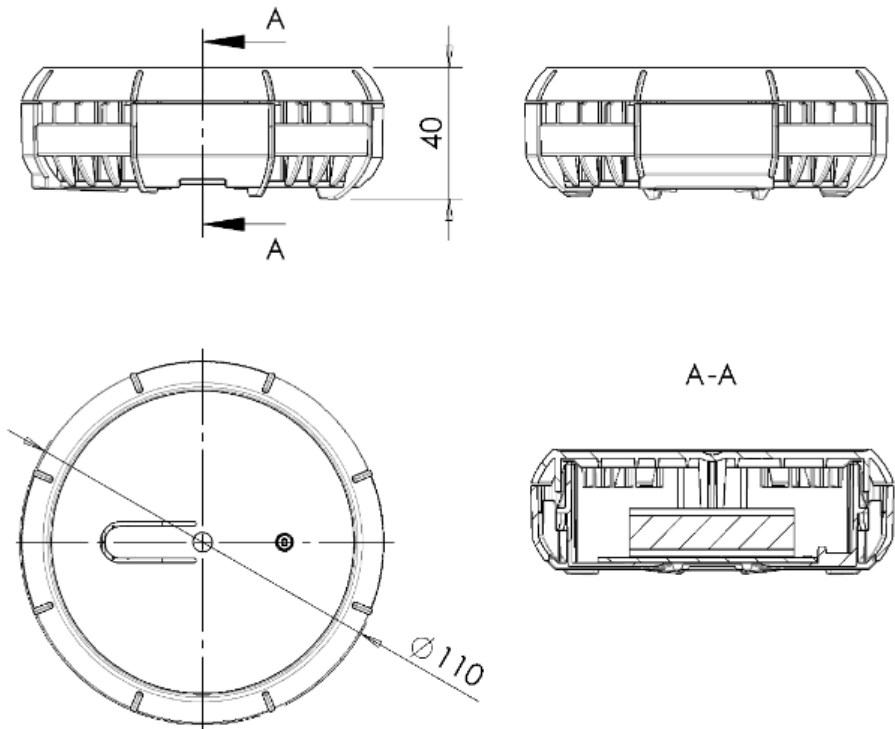

Fig. 3: Dimensions in mm

4.3 Technical data

Description	Value
Dimensions	Ø 110 mm, height 40 mm
Operational temperature range	0 °C to a maximum of 40 °C
Temperature class	T4 (max.135 °C)
Explosion protection group	II B
Ignition protection type	Intrinsically safe
Equipment category	1G
Weight	140 g
Nominal voltage	3.6 V
Lifespan	Max. 5 years
Liquid level required to wet the sensor	6 mm
Noise in accordance with DIN EN ISO 3744	91.6 dB (A)
EC type examination certificate	BVS 19 ATEX E 077 IECEX BVS 19.0073
FM certificate	FM 20 US 0051 FM 20 CA 0023



The recommended operational temperature range is the basis for the specified service life of 5 years. SpillGuard® may also be used at a temperature down to max. -10°C. The specified service life of 5 years cannot be guaranteed however in this temperature range. Repeated false alarms can be triggered if the temperature fluctuates around the dew point.

4.3.1 Explanation of the nameplate



Fig. 4: Schematic representation CE

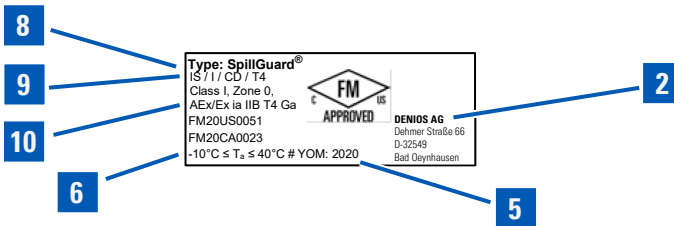

Fig. 5: Schematic representation FM

- 1 CE marking
- 2 Name and address of the manufacturer
- 3 Product marking
- 4 Ex marking
- 5 Year of manufacture / serial number
- 6 Ambient temperature range T_a
- 7 EC type examination certificate
- 8 Product type
- 9 FM marking
- 10 FM certificate

5 Installation

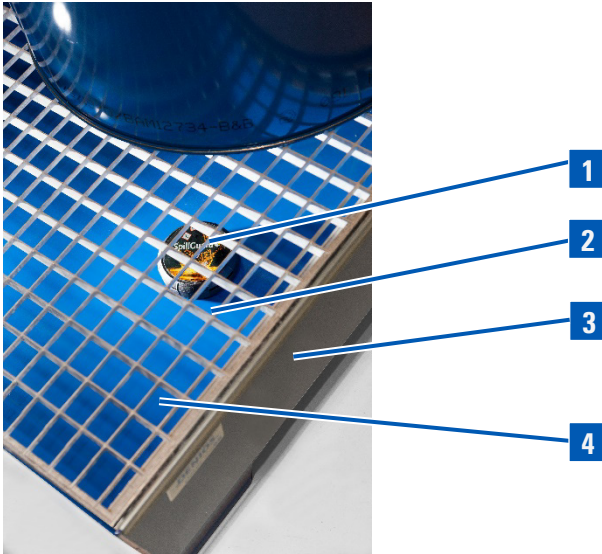

Fig. 6: SpillGuard® in spill sump

- 1 SpillGuard®
- 2 Grid
- 3 Spill sump
- 4 Base of the spill sump

5.1 Requirements for the installation location

This chapter gives information and instructions for the safe installation of the product: SpillGuard®'s location of use is the base of a spill sump.



WARNING



Possible ignition of an explosive atmosphere.

If the product is damaged during storage or removal of containers, a potentially explosive atmosphere may be ignited.

- Place and operate the device in such a way that damage is excluded.

The following prerequisites must be met:

- The base of the spill sump must be free of any type of contamination.
- The base must be level.
- There must be sufficient space available for the product.
- The location of use should be at the lowest point of the spill sump so that a leak is detected as early as possible.

6 Operation



CAUTION







Irritation from direct contact with the hazardous substance.

Injury possible to hands, eyes etc.

- Wear personal protective equipment (PPE).

6.1 Commissioning the product





Perform the following action

- ✓ The product is correctly unpacked.
- ✓ The product is undamaged.
- 1. Position the product at the lowest point of the spill sump with the sensor surface towards the bottom.
- 2. Press and hold the push button until the beep  is heard.
 - ⇒ LED  flashes quickly.
- 3. Wait 30 seconds until the calibration process is complete.
 - ⇒ Two beeps  are heard.
 - ⇒ LED  flashes once a minute.
- The product is ready for operation.

6.2 Using the product in a new location



If you wish to use the product in a new location, the product must first be switched off and then switched back on again.

Perform the following action

1. Press and hold the push button until the beep  is heard.
⇒ The product is switched off.
2. Position the product in the new location.
3. Press and hold the push button until the beep  is heard.
⇒ LED  flashes quickly.
4. Wait 30 seconds until the calibration process is complete.
⇒ Two beeps  are heard.
⇒ LED  flashes once a minute.
 The product is ready for operation.

6.3 Carrying out measures if the alarm is triggered

If a leak is detected, the following signals are given:

-  5 beeps, 15 second pause
-  Rapid flashing during the pause



When handling hazardous substances, observe the safety instructions in the safety data sheet for the leaked hazardous substance, see *Compliance with the requirements of the safety data sheet* [▶ 12].

Perform the following action

1. Carry out measures to clean up the leak.

CAUTION! Irritation from direct contact with the hazardous substance. Injury possible to hands, eyes etc. Wear personal protective equipment (PPE).

2. Remove liquids from the spill sump without delay and clean.
3. Press and hold the push button (> 1 s and < 10 s).
 - ⇒ A beep  is heard.
 - ⇒ The product is switched off.
4. Check the spill sump for damage and integrity.

Decommission the product: *Decommissioning* [▶ 29]

7 **Faults and incorrect operation**

This chapter gives information on possible faults. It also describes the measures to take to clear these faults.

7.1 **Possible faults**

Fault	Possible cause	Remedy
Alarm-like beep with no leak: 2 beeps, 0.1 s between beeps, pause Illuminates with the same duration and frequency as the beep	Low battery	Replace SpillGuard® with a new unit
Alarm triggered with no leak	Under certain climatic conditions condensation can form on the sensor surface. This can trigger a false alarm.	<ol style="list-style-type: none"> 1. Press and hold the push button (> 1 s and < 10 s) to switch off the alarm. 2. Clean the sensor surface with a soft, lint-free cloth. 3. Press and hold the push button until a beep is heard. <p>⇒ SpillGuard® is ready to use again after 30 seconds.</p> <p>[▶ 24]</p>

Faults and incorrect operation

SpillGuard® will not switch on	Push button not held for long enough	Press and hold the push button until beep is heard
	Battery faulty or drained	Replace SpillGuard® with a new unit
Leak is not detected by SpillGuard®	The location has been changed without recalibrating	Switch the product on again if the location of use is changed.
	Required liquid level was not reached	SpillGuard® only detects when the sensor surface is wet. This means that a minimum liquid level of 6mm must first be reached.
	SpillGuard® is not positioned in the lowest part of the spill sump	Position SpillGuard® at the lowest part of the spill sump
SpillGuard® cannot be switched off after an alarm	The push button was NOT pressed for the required time	Press and hold the push button until the beep is heard (> 1 s and < 10 s)
SpillGuard® cannot be switched off when operational	The push button was NOT pressed for the required time	Press and hold the push button until the beep is heard

8 Maintenance

The product is maintenance free. Due to its construction, repair or replacement of the components is not possible.

After 5 years of use, the product must be replaced to guarantee fault-free leak detection.

9 Decommissioning



When handling hazardous substances, observe the safety instructions in the safety data sheet for the leaked hazardous substance, see Compliance with the requirements of the *safety data sheet* [▶ 12].



CAUTION



Irritation from direct contact with the hazardous substance.

Injury possible to hands, eyes etc.

- Wear personal protective equipment (PPE).

9.1 Switching off

Perform the following action

- ✓ The end of life has been reached or a leak has been detected.
1. Press and hold the push button until the beep  is heard.
- The product is switched off.

9.2 Cleaning

Perform the following action

- ✓ The product is switched off.
- 1. Thoroughly clean the product of all hazardous substance residues.

WARNING! If the housing is opened in Ex atmospheres there is a risk of explosion. Opening the housing can lead to severe injuries or death. Opening the housing is prohibited.

- The product has been cleaned.

10 Disposal



Use established local collection points for disposal or return the product to DENIOS.

Perform the following action

- ✓ The product has been cleaned.
- 1. Do not dispose of the product in a normal household waste bin; observe the relevant national regulations.
- The product is properly disposed of.

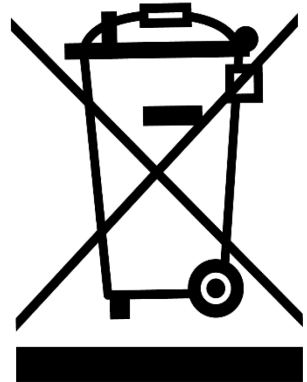

11 EU conformity

SpillGuard® is certified in accordance with directive 2014/34/EU (ATEX directive). Production is monitored by regular and independent inspections for continuous compliance with legal and normative requirements.



SpillGuard® meets the basic requirements for the protection of health, safety and environmental protection in the following directives:

- 2014/30/EU (EMV)
- 2011/65/EU (RoHS 2)

The EU Declaration of Conformity can be found at:

 www.denios.com/spillguard



DENIOS.

271081